

**Preisliste / Price list**

# Original PERROT

**Schnellkupplungsprogramm für  
Rohre, Formstücke und Zubehör**

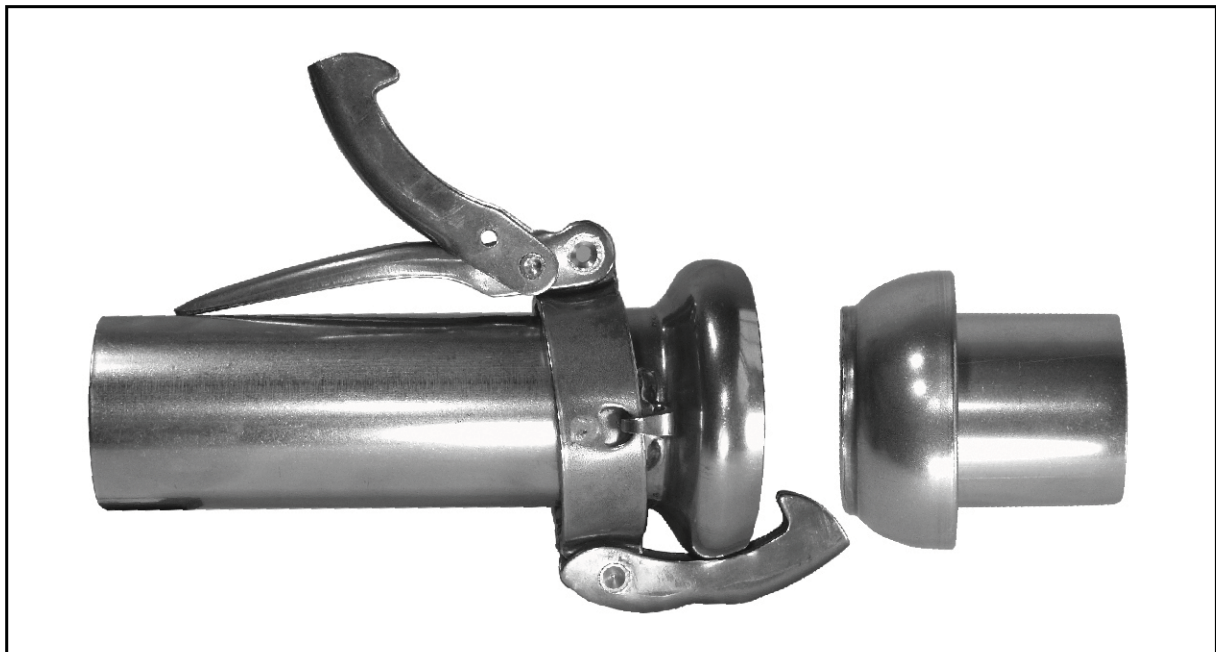

**Volker Pröhl GmbH**

**Am Gansacker 24**

**D - 79224 Umkirch bei Freiburg**

Telefon +49 (0)7665 - 7022 ☆ Telefax +49 (0)7665 - 51524

E-mail [info@proehl-gmbh.de](mailto:info@proehl-gmbh.de) ☆ Internet [www.berechnungsprofi.com](http://www.berechnungsprofi.com)

# Schnellkupplungsrohre und Formstücke mit Kardangelenkkupplung

**Lieferumfang:** Zu den Mutterkupplungsteilen der Rohre und Formstücke gehört je ein Gummidichtungsring, der jeweils im Preis enthalten ist. Die Dichtungsringe sind vormontiert. Stützfüße gehören nicht zum Lieferumfang von Rohren und Formstücken und sind nach Wunsch gesondert zu bestellen. Die Stützfüße kommen unmontiert zur Lieferung.

**Werkstoff:** Rohre aus Bandstahl, längsgeschweißt und feuerverzinkt; Kupplungskörper und Hebelwerk aus Stahlblech, beides schwarz oder feuerverzinkt. Für Kupplungen aus Edelstahl (1.4404) siehe separate Liste.

**Norm:** Feuerverzinkung nach DIN 2444. Technische Lieferbedingungen für Schnellkupplungsrohre (Durchmesser, Wanddicke, Korrosionsbeständigkeit, Druck, usw.) Nach DIN 19651(alt)/ DIN EN12734(neu).

**Betriebsdruck:** Betriebsdruck bis 10 bar. Höhere Drücke auf Anfrage.

**Abwinkelung:** 15° nach jeder Richtung.

**Kardan M-Teile und Formstücke mit M-Teil sind auch mit Kardanring und Hebelwerk aus Temperguss lieferbar. Preis auf Anfrage.**

## Quick-coupling Pipes and Fittings with Cardan-joint Coupling

**Execution:** A rubber seal-ring is supplied for the female part of pipes and fittings and included in their price. The seal-rings are mounted. All pipes and fittings are without prop-foot. Prop-feet are available on special order and likewise are delivered unmounted.

**Material:** Pipes of sheet-steel longitudinally welded and galvanized. Coupling and lever arrangement made of sheet-steel; both black or hot dipped galvanized. Couplings in stainless steel (1.4404) shown on a separate list.

**Standard:** Galvanized as per Standards-draft DIN 2444. Normal-flow-direction as in usage-standards shown by arrows. Technical delivery conditions for Quick-coupling Pipes (diameter, wall-thickness, corrosion-resistance, pressure etc.) as per DIN 19651(old) / DIN EN 12734 (new).

**Pressure:** Operating pressure 10 bar (stronger designs on request).

**Angle of deflection:** 15° in any direction.

**Cardan female couplings and fittings with female coupling can be also produced with ring, hooks and lever in cast iron. Prices on request.**

### Reibungsverluste in Schnellkupplungsrohren (in m auf 100m Rohr) Pertes par friction dans les tubes à accouplement ( en m par 100m de tubu) Friction losses in quick-coupling pipes (in m per 100m pipe)

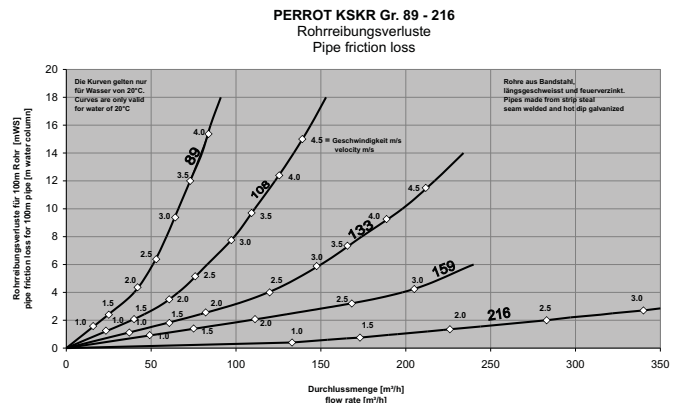
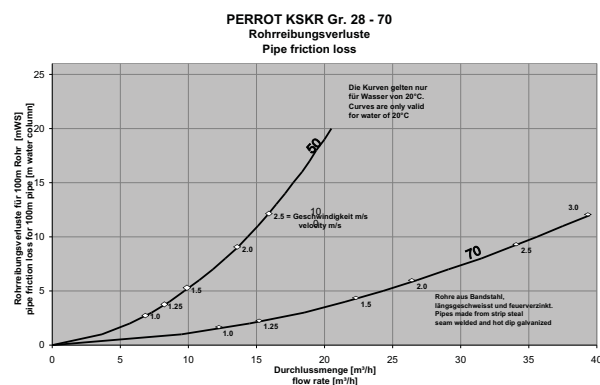

# Preisliste

Schnellkupplungsrohr	Ø mm	Länge	Bestellwort	Artikel-Nr.	Preis ohne MwSt. Euro
Normallänge	50	6 mtr.	<b>KSKR 50</b>	KRR1 55 000	<b>auf Anfrage</b>
	70		<b>KSKR 70</b>	KRS1 55 060	
	89		<b>KSKR 89</b>	KRT1 55 120	
	108		<b>KSKR 108</b>	KRU1 55 180	
	133		<b>KSKR 133</b>	KRV1 55 240	
	159		<b>KSKR 159</b>	KRW1 55 300	
Untерlänge	50	5 mtr.	<b>KSKR 50/5</b>	KRR1 55 010	<b>59,86</b>
	70		<b>KSKR 70/5</b>	KRS1 55 070	<b>77,07</b>
	89		<b>KSKR 89/5</b>	KRT1 55 130	<b>97,46</b>
	108		<b>KSKR 108/5</b>	KRU1 55 190	<b>140,62</b>
	133		<b>KSKR 133/5</b>	KRV1 55 250	<b>188,68</b>
	159		<b>KSKR 159/5</b>	KRW1 55 310	<b>282,18</b>
Untерlänge	50	4 mtr.	<b>KSKR 50/4</b>	KRR1 55 020	<b>51,90</b>
	70		<b>KSKR 70/4</b>	KRS1 55 080	<b>67,53</b>
	89		<b>KSKR 89/4</b>	KRT1 55 140	<b>90,18</b>
	108		<b>KSKR 108/4</b>	KRU1 55 200	<b>126,57</b>
	133		<b>KSKR 133/4</b>	KRV1 55 260	<b>168,28</b>
	159		<b>KSKR 159/4</b>	KRW1 55 320	<b>246,01</b>
Untерlänge	50	3 mtr.	<b>KSKR 50/3</b>	KRR1 55 030	<b>47,94</b>
	70		<b>KSKR 70/3</b>	KRS1 55 090	<b>58,92</b>
	89		<b>KSKR 89/3</b>	KRT1 55 150	<b>84,21</b>
	108		<b>KSKR 108/3</b>	KRU1 55 210	<b>109,25</b>
	133		<b>KSKR 133/3</b>	KRV1 55 270	<b>146,17</b>
	159		<b>KSKR 159/3</b>	KRW1 55 330	<b>209,87</b>
Untерlänge	50	2 mtr.	<b>KSKR 50/2</b>	KRR1 55 040	<b>42,37</b>
	70		<b>KSKR 70/2</b>	KRS1 55 100	<b>50,32</b>
	89		<b>KSKR 89/2</b>	KRT1 55 160	<b>78,11</b>
	108		<b>KSKR 108/2</b>	KRU1 55 220	<b>93,61</b>
	133		<b>KSKR 133/2</b>	KRV1 55 280	<b>128,16</b>
	159		<b>KSKR 159/2</b>	KRW1 55 340	<b>174,52</b>
Untерlänge	50	1 mtr.	<b>KSKR 50/1</b>	KRR1 55 050	<b>39,59</b>
	70		<b>KSKR 70/1</b>	KRS1 55 110	<b>46,88</b>
	89		<b>KSKR 89/1</b>	KRT1 55 170	<b>72,17</b>
	108		<b>KSKR 108/1</b>	KRU1 55 230	<b>83,43</b>
	133		<b>KSKR 133/1</b>	KRV1 55 290	<b>114,54</b>
	159		<b>KSKR 159/1</b>	KRW1 55 350	<b>152,27</b>

Bezeichnung / Abbildung	Bestellwort	Artikel-Nr.	Preis ohne MwSt. Euro
<u>Kupplungen</u>	<b>KKV 50</b>	KTJ0 51 001	<b>1,31</b>
Kardan V-Teil, Schwarz, zum Auf- und Anschweissen	<b>KKV 70</b>	KTJ0 52 001	<b>1,95</b>
	<b>KKV 89</b>	KTJ0 53 001	<b>3,91</b>
	<b>KKV 108</b>	KTJ0 54 010	<b>6,23</b>
	<b>KKV 133</b>	KTJ0 54 212	<b>9,22</b>
	<b>KKV 159</b>	GTK0 54 410	<b>11,43</b>
	<b>KKV 216</b>	GTK0 54 502	<b>54,58</b>
	Kardan M-Teil+Kardanring schwarz, zum Auf- und Anschweissen (Hebelwerk verzinkt), unmontiert	<b>KKM 50</b>	KKR1 51 025
<b>KKM 70</b>		KKS1 52 026	<b>12,87</b>
<b>KKM 89</b>		KKT1 53 025	<b>19,23</b>
<b>KKM 108</b>		KKU1 54 024	<b>33,13</b>
<b>KKM 133</b>		KKV1 54 211	<b>46,12</b>
<b>KKM 159</b>		KKW1 54 400	<b>55,87</b>
<b>KKM 216</b>		KKX2 54 514	<b>174,11</b>
Gr. 216 - komplett schwarz	<b>KKMM 50</b>	KKR0 51 034	<b>12,35</b>
Kardan M-Teil Komplett, schwarz, zum Auf-und Anschweissen montiert	<b>KKMM 70</b>	KKS0 52 036	<b>17,55</b>
	<b>KKMM 89</b>	KKT0 53 037	<b>25,47</b>
	<b>KKMM 108</b>	KKU0 54 038	<b>37,81</b>
	<b>KKMM 133</b>	KKV0 54 224	<b>49,25</b>
	<b>KKMM 159</b>	KKW0 54 418	<b>58,99</b>
	<b>KKMM 216</b>	KKX2 54 523	<b>195,00</b>







# Preisliste

Bezeichnung / Abbildung	Bestellwort	Artikel-Nr.	Preis ohne MwSt. Euro		
<u>Schlauchtüllen- Formstücke</u>  Kardan-V-Teil mit gedrehter Schlauchtülle		KVS-K 50 x 50	KFR1 76 260	12,99	
		KVS-K 70 x 60	KFS1 76 270	19,23	
		KVS-K 70 x 65	KFS1 76 280	21,70	
		KVS-K 70 x 70	KFS1 76 290	21,70	
		KVS-K 70 x 75	KFS1 76 292	23,13	
		KVS-K 89 x 75	KFT1 76 300	23,91	
		KVS-K 89 x 80	KFT1 76 310	24,05	
		KVS-K 89 x 90	KFT1 76 320	24,69	
		KVS-K 108 x 100	KFU1 76 370	36,26	
		KVS-K 108 x 110	KFU1 76 380	36,38	
		KVS-K 133 x 125	KFV1 76 420	43,14	
		KVS-K 159 x 150	KFW1 76 460	54,98	
		Kardan-M-Teil mit gedrehter Schlauchtülle		KMS-K 50 x 50	KFR1 76 540
KMS-K 70 x 60	KFS1 76 550			32,35	
KMS-K 70 x 65	KFS1 76 560			33,13	
KMS-K 70 x 70	KFS1 76 570			39,25	
KMS-K 70 x 75	KFS1 76 572			43,02	
KMS-K 89 x 75	KFT1 76 580			46,25	
KMS-K 89 x 80	KFT1 76 590			46,25	
KMS-K 89 x 90	KFT1 76 600			48,59	
KMS-K 108 x 100	KFU1 76 650			66,27	
KMS-K 108 x 110	KFU1 76 660			68,74	
KMS-K 133 x 125	KFV1 76 700			90,31	
KMS-K 159 x 150	KFW1 76 740			115,64	
Kardan-V-Teil mit gesickter Schlauchtülle				KVS-Si 50 x 50	KFR1 75 810
		KVS-Si 70 x 70	KFS1 75 830	11,70	
		KVS-Si 89 x 75	KFT1 75 843	14,81	
		KVS-Si 89 x 80	KFT1 75 840	14,81	
		KVS-Si 89 x 90	KFT1 75 850	14,81	
		KVS-Si 108 x 75	KFU1 75 863	22,87	
		KVS-Si 108 x 100	KFU1 75 860	21,45	
		KVS-Si 108 x 110	KFU1 75 870	21,45	
		KVS-Si 133 x 125	KFV1 75 880	25,34	
		KVS-Si 159 x 150	KFW1 75 890	28,46	
		Kardan-M-Teil mit gesickter Schlauchtülle		KMS-Si 50 x 50	KFR1 75 910
KMS-Si 70 x 70	KFS1 75 930			28,84	
KMS-Si 89 x 75	KFT1 75 942			41,58	
KMS-Si 89 x 80	KFT1 75 940			40,03	
KMS-Si 89 x 90	KFT1 75 950			37,67	
KMS-Si 108 x 75	KFU1 75 964			54,69	
KMS-Si 108 x 100	KFU1 75 960			47,82	
KMS-Si 108 x 110	KFU1 75 970			54,69	
KMS-Si 133 x 125	KFV1 75 980			72,51	
KMS-Si 159 x 150	KFW1 75 990			80,18	
<u>Anschluss- Formstücke</u>  Kardan-V-Teil mit Gewindestutzen				KVG 50 x 1½"	KFR1 73 420
		KVG 50 x 2"	KFR1 74 270	16,24	
		KVG 70 x 2"	KFS1 74 280	18,97	
		KVG 70 x 2½"	KFS1 73 430	19,23	
		KVG 89 x 3"	KFT1 73 440	26,12	
		KVG 108 x 3"	KFU1 73 455	36,26	
		KVG 108 x 4"	KFU1 73 450	36,26	
		KVG 133 x 5"	KFV1 73 460	47,82	
		KVG 159 x 6"	KFW1 73 470	53,15	
		Wie oben, jedoch mit Innengewinde	KVG 50 x 2" iG	KFR1 74 271	18,57

# Preisliste

Bezeichnung / Abbildung	Bestellwort	Artikel-Nr.	Preis ohne MwSt. Euro
Kardan-M-Teil mit Gewindestutzen  	KMG 50 x 1½"	KFR1 73 540	29,89
	KMG 50 x 2"	KFR1 74 290	33,13
	KMG 70 x 2"	KFS1 74 300	41,58
	KMG 70 x 2½"	KFS1 73 550	43,92
	KMG 89 x 3"	KFT1 73 560	52,37
	KMG 108 x 3"	KFU1 73 574	69,38
	KMG 108 x 4"	KFU1 73 570	75,51
	KMG 133 x 5"	KFV1 73 580	105,77
	KMG 159 x 6"	KFW1 73 590	119,93
Wie oben, jedoch mit Innengewinde	KMG 50 x 2" iG	KFR1 74 292	40,80
Kardan-V-Teil mit Flansch PN 10  	KVF 50 x 50	KFR1 71 861	34,30
	KVF 70 x 65	KFS1 71 871	53,15
	KVF 89 x 80	KFT1 71 881	55,48
	KVF 108 x 100	KFU1 71 891	67,83
	KVF 133 x 125	KFV1 71 901	88,62
	KVF 159 x 150	KFW1 71 911	111,09
Kardan-M-Teil mit Flansch PN 10  	KMF 50 x 50	KFR1 71 982	46,90
	KMF 70 x 65	KFS1 71 992	60,55
	KMF 89 x 80	KFT1 72 002	77,05
	KMF 108 x 100	KFU1 72 012	97,06
	KMF 133 x 125	KFV1 72 022	138,52
	KMF 159 x 150	KFW1 72 032	167,10
Kardan-V-Teil mit Gülleflansch Länge 150 mm  	KVF 108 x 100 GÜ	KFU1 71 895	45,09
	KVF 133 x 125 GÜ	KFV1 71 903	50,42
	KVF 159 x 150 GÜ	KFW1 71 914	57,82
Kardan M-Teil mit Gulleflansch  	KMF 108 x 100 GÜ	KFU1 72 014	74,06
	KMF 133 x 125 GÜ	KFV1 72 024	92,38
	KMF 159 x 150 GÜ	KFW1 72 029	97,06
	KMF 108 x 100 GÜ	KFU1 72 015	88,62
	KMF 133 x 125 GÜ	KFV1 72 025	105,48
	KMF 159 x 150 GÜ	KFW1 72 034	112,90
Kardan-V-Teil mit Kurzrohrstutzen Zum Anschweissen verzinkt  	KVR 50	KFR1 73 000	6,50
	KVR 70	KFS1 73 010	7,80
	KVR 89	KFT1 73 020	14,30
	KVR 108	KFU1 73 030	21,18
	KVR 133	KFV1 73 040	26,64
	KVR 159	KFW1 73 050	35,48
Kardan-M-Teil mit Kurzrohrstutzen zum Anschweissen verzinkt  	KMR 50	KFR1 73 120	23,91
	KMR 70	KFS1 73 130	30,03
	KMR 89	KFT1 73 140	33,90
	KMR 108	KFU1 73 150	57,96
	KMR 133	KFV1 73 160	74,06
	KMR 159	KFW1 73 170	90,95
Kardan-V-Endstopfen  	KVX 50	KFR1 71 740	3,13
	KVX 70	KFS1 71 750	7,40
	KVX 89	KFT1 71 760	8,72
	KVX 108	KFU1 71 770	11,37
	KVX 133	KFV1 71 780	20,14
	KVX 159	KFW1 71 790	21,45



# Preisliste

Bezeichnung / Abbildung	Bestellwort	Artikel-Nr.	Preis ohne MwSt. Euro
Kardan-M-Endstück 	KMX 50 KMX 70 KMX 89 KMX 108 KMX 133 KMX 159	KFR1 71 560 KFS1 71 570 KFT1 71 580 KFU1 71 590 KfV1 71 600 KFW1 71 610	12,99 15,59 23,38 38,98 53,28 67,57
<b>Formstücke</b>			
Kardan-Bogen 90° 	KRKB 50 / 90° KRKB 70 / 90° KRKB 89 / 90° KRKB 108 / 90° KRKB 133 / 90° KRKB 159 / 90°	KFR1 71 260 KFS1 71 300 KFT1 71 340 KFU1 71 380 KfV1 71 420 KFW1 71 460	51,98 55,36 68,61 113,31 149,43 215,18
Kardan-Bogen 45° 	KRKB 50 / 45° KRKB 70 / 45° KRKB 89 / 45° KRKB 108 / 45° KRKB 133 / 45° KRKB 159 / 45°	KFR1 71 280 KFS1 71 320 KFT1 71 360 KFU1 71 400 KfV1 71 440 KFW1 71 480	38,60 45,54 65,34 105,44 142,31 204,93
Kardan-Bogen 30° 	KRKB 50 / 30° KRKB 70 / 30° KRKB 89 / 30° KRKB 108 / 30° KRKB 133 / 30° KRKB 159 / 30°	KFR1 71 290 KFS1 71 330 KFT1 71 370 KFU1 71 410 KfV1 71 450 KFW1 71 490	35,60 43,54 63,20 101,35 138,21 199,95
Kardan-Reduzierstück 	KKMGV 70 x 50 KKMGV 89 x 50 KKMGV 89 x 70 KKMGV 108 x 70 KKMGV 108 x 89 KKMGV 133 x 89 KKMGV 133 x 108 KKMGV 159 x 108 KKMGV 159 x 133	KFS1 71 130 KFT1 74 310 KFT1 71 140 KFU1 74 320 KFU1 71 150 KfV1 74 360 KfV1 71 160 KFW1 74 330 KFW1 71 170	30,53 34,82 39,63 58,99 67,31 85,11 86,40 108,50 125,00
Kardan-Erweiterungsstück 	KGMKV 50 x 70 KGMKV 50 x 89 KGMKV 70 x 89 KGMKV 70 x 108 KGMKV 89 x 108 KGMKV 89 x 133 KGMKV 89 x 159 KGMKV 108 x 133 KGMKV 108 x 159 KGMKV 133 x 159	KFR1 71 180 KFR1 74 340 KFS1 71 190 KFS1 71 200 KFT1 71 210 KFT1 71 220 KFT1 71 240 KFU1 71 230 KFU1 74 350 KfV1 71 250	41,96 52,63 53,39 73,55 98,36 103,44 117,85 114,08 127,21 129,68
Kardan-Umkehrstück 2 x M-Teil 	KDMT 50 KDMT 70 KDMT 89 KDMT 108 KDMT 133 KDMT 159	KFR1 73 360 KFS1 73 370 KFT1 73 380 KFU1 73 390 KfV1 73 400 KFW1 73 410	50,81 68,22 94,47 106,94 154,23 180,74

# Preisliste

Bezeichnung / Abbildung	Bestellwort	Artikel-Nr.	Preis ohne MwSt. Euro
Kardan- Umkehrstück 2 x V-Teil 	KDVT 50	KFR173300	23,91
	KDVT 70	KFS173310	30,86
	KDVT 89	KFT173320	40,90
	KDVT 108	KFU173330	50,91
	KDVT 133	KFV173340	70,98
	KDVT 159	KFW173350	78,71
Kardan-Abzweig T-Stück 	KT 50 x 50	KFR1 73 720	50,28
	KT 70 x 50	KFS1 73 730	59,78
	KT 70 x 70	KFS1 73 740	64,96
	KT 89 x 50	KFT1 73 750	96,41
	KT 89 x 70	KFT1 73 760	97,95
	KT 89 x 89	KFT1 73 770	110,31
	KT 108 x 70	KFU1 73 780	113,44
	KT 108 x 89	KFU1 73 790	130,98
	KT 108 x 108	KFU1 73 800	146,97
	KT 133 x 108	KFV1 73 810	194,40
	KT 133 x 133	KFV1 73 820	212,97
	KT 159 x 108	KFW1 73 830	215,57
	KT 159 x 133	KFW1 73 840	238,83
KT 159 x 159	KFW1 73 850	300,04	
Kardan T-Stück mit Schieber 	KT 70 x P70	KFS1 73 980	162,81
	KT 89 x P70	KFT1 74 000	184,51
	KT 108 x P70	KFU1 74 020	213,35
Kardan Streckenschieber 	KZA 50 x 1½"	KFR1 71 500	80,96
	KZA 70 x 2½"	KFS1 71 510	129,41
	KZA 89 x 3"	KFT1 71 520	181,26
	KZA 108 x 4"	KFU1 71 530	208,29
	KZA 133 x 5"	KFV1 71 540	426,56
	KZA 159 x 6"	KFW1 71 550	598,61
<u>Zubehör</u>			
Kardan-Saugkorb 	KSK 70	KFS6 38 028	198,17
	KSK 89	KFT6 38 076	229,08
	KSK 108	KFU6 38 126	258,45
Hydranten-Unterteil mit 3" IG, verzinkt 	HUY 3"	HYK1 50 140	61,98
Hydranten-Oberteil (Aluguss) mit Kardan-Abgang 	HOKL 70	HYS1 50 176	240,11
	HOKL 89	HYT1 50 194	247,52
	HOKL 108	HYU1 50 195	251,03
dito, mit Gewindeabgang IG	HOKL 2½"	HBL5 50 175	187,37
	HOKL 3"	HBL5 50 200	187,37

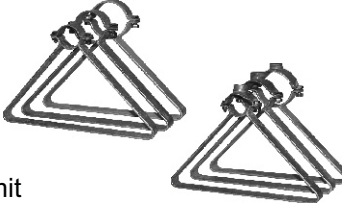
# Preisliste

Bezeichnung / Abbildung	Bestellwort	Artikel-Nr.	Preis ohne MwSt. Euro
<i>description / illustration</i>			
Stützfuß 	KRS 50 KRS 70 KRS 89	KRR1 79 855 KRS1 79 865 KRT1 79 875	12,83 21,02 22,58
Stützfuß mit Regneranschluss	KRS 50/IA KRS 70/IA KRS 89/IA	KRR1 79 856 KRS1 79 866 KRT1 79 876	13,56 23,71 25,55
Regner-Anschluss-schelle mit 1/2" Innen- und 1" Aussengewinde 	SLK 50 / IA SLK 70 / IA SLK 89 / IA	SKR1 20 430 SKS1 20 432 SKT1 20 434	6,50 8,04 9,62
Schellen mit Dichtung, Schrauben und Muttern			

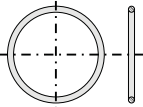
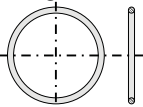
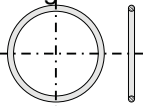
Bezeichnung / Abbildung	Masse ca. Mm	Bestellwort	Artikel-Nr.	Preis ohne MwSt. Euro
<u>Gummiringe</u>	86 64 110 87 140 112 160 124 190 146 224 180 304 255	KKG 50 KKG 70 KKG 89 KKG 108 KKG 133 KKG 159 KKG 216	KTQ7 51 003 KTQ7 52 003 KTQ7 53 003 KTQ7 54 012 KTQ7 54 213 KTQ7 54 411 KTQ7 54 516	0,67 1,19 2,05 3,41 4,76 5,45 9,25
Kardan-Gummi- dichtungsring für Normal- einsatz 	86 64 110 87 140 112 160 124 190 146 224 180	KKG/O 50 KKG/O 70 KKG/O 89 KKG/O 108 KKG/O 133 KKG/O 159	KTQ7 51 011 KTQ7 52 012 KTQ7 53 012 KTQ7 54 016 KTQ7 35 019 KTQ7 36 023	2,05 2,72 4,09 5,72 7,48 10,89
Kardan- Gummidichtungsring ölfest 	86 64 110 87 140 112 160 124 190 146 224 180	KKG/E 50 KKG/E 70 KKG/E 89 KKG/E 108 KKG/E 133 KKG/E 159	KTQ7 51 012 KTQ7 52 013 KTQ7 53 013 KTQ7 54 017 KTQ7 35 020 KTQ7 36 024	2,05 3,17 4,09 6,00 12,25 14,98
Kardan- Gummidichtungsring heisswasser- beständig 	86 64 110 87 140 112 160 124 190 146 224 180	KKG/Hw 50 KKG/Hw 70 KKG/Hw 89 KKG/Hw 108 KKG/Hw 133 KKG/Hw 159	KTQ7 51 013 KTQ7 52 014 KTQ7 53 014 KTQ7 54 014 KTQ7 54 220 KTQ7 54 419	2,05 2,72 4,09 5,72 7,49 11,72

## Weitere Kardan-Formteile auf Anfrage.

Preisstellung ab Werk ohne Verpackung, zuzüglich der am Tage der Lieferung gültigen Mehrwertsteuer. Im übrigen gelten unsere allgemeinen Lieferbedingungen. Änderungen ohne vorherige Ankündigung vorbehalten.



## Volker Pröhl GmbH

Am Gansacker 24

D - 79224 Umkirch bei Freiburg

Telefon +49 (0)7665 - 7022 ☆ Telefax +49 (0)7665 - 51524

E-mail info@proehl-gmbh.de ☆ Internet www.berechnungsprofi.com